

---

---

# OWNER'S MANUAL

---

---

Vintage Classic HEAT COOL models

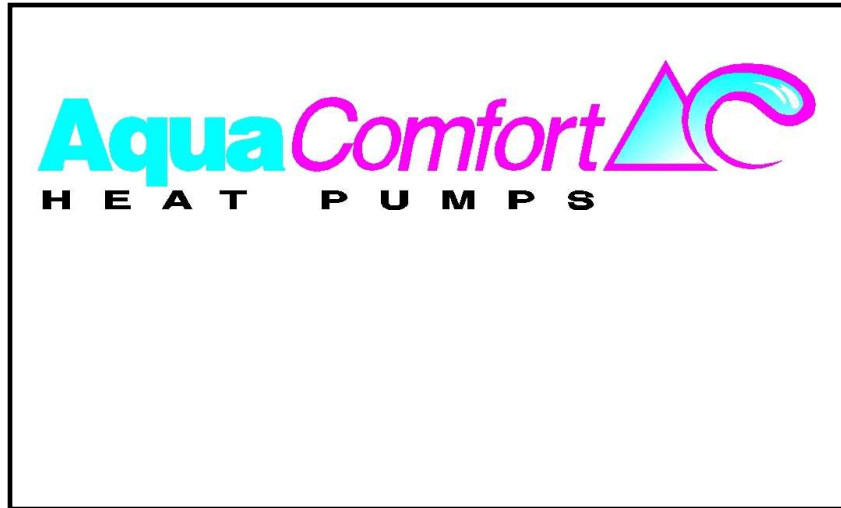

Manufacturing High Quality, High Efficiency  
**Heat Pump Pool Heaters**

## TABLE OF CONTENTS

SAFETY CONSIDERATIONS	2
INSPECTION	2
GENERAL INFORMATION	2
INSTALLATION	2
WATER FLOW & CONNECTIONS	2-3
ELECTRICAL CONNECTIONS	4
MODES OF OPERATION	5
WIRING DIAGRAMS	6
ELECTRONIC CONTROL PANEL	7-8
CHEMICAL USE	9
START-UP	10-11
MAINTENANCE	12
TROUBLESHOOTING CHECKLIST	12-13
CALLING FOR SERVICE	14
WARRANTY	15
WARRANTY REGISTRATION	16

## MODEL:

**HEAT & COOL**

**INSTALLATION,  
OPERATION,  
MAINTENANCE  
& SERVICE**

## **SAFETY CONSIDERATIONS**

- Qualified personnel should perform installation, maintenance and service.
- Make sure all field wiring conforms to the heater specifications and all national and local codes.
- Disconnect all power sources before performing any maintenance or service to the heater.

## **INSPECTION**

Immediately upon receipt, inspect cartons and their contents for damage due to transit. Damage, if found, should be noted on delivery papers and a claim filed with the carrier. Also, check unit data plate to make sure you have the proper model, before installing.

## **GENERAL INFORMATION**

The information in this manual was prepared to assist in the proper installation, operation, maintenance and service of your new heat pump pool heater. Please read the entire manual and follow all instructions. Improper installation and use can result in damage to the heater, unsatisfactory operation, and may void the warranty. Retain this manual for quick reference.

---

## **INSTALLATION**

---

When selecting a location consider the following:

- Heater must be located outdoors.
- Minimum of 24” of clearance on access / service side of heater.
- Minimum of 18” of clearance on all three air intake sides of heater.
- Minimum of 48” of clearance for air discharge (top of unit).
- The heater should sit on a solid level surface sufficient above grade to prevent water from entering it, and allowing condensate to drain from base.
- The length of water piping and electric should be kept to a minimum to avoid capacity loss and decreased efficiency.

---

## **WATER FLOW & CONNECTIONS**

---

Water connections are made at the rear of the heater. Both water in and out are labeled at the water connections. LEFT REAR = WATER IN and RIGHT REAR = WATER OUT. 2” unions are supplied and are made to accept 2” rigid PVC pipe. NOTE: unions can be used for quick drainage of your heater and winterizing.

- Heater must be piped downstream from filter in the pool return line.
- Inline chlorinators must be piped downstream from heater. A check valve should be installed between the heater and chlorinator to prevent drain back of the chlorine when the pump is off. A chemical trap may also be piped at least six (6) inches above the height of the chlorinator.

- When all the plumbing connections are complete, and ample drying time is allowed, run the filter pump and check the entire system for water leaks.
- Make sure filter is clean and there are no obstructions in the filtering system.
- Proper water flow is essential to the performance of your heater. The minimum flow rate is 20 GPM.

## TYPICAL WATER FLOW CONNECTIONS

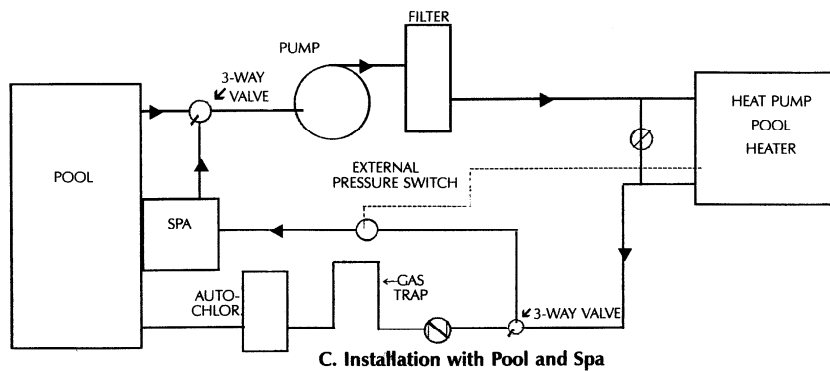
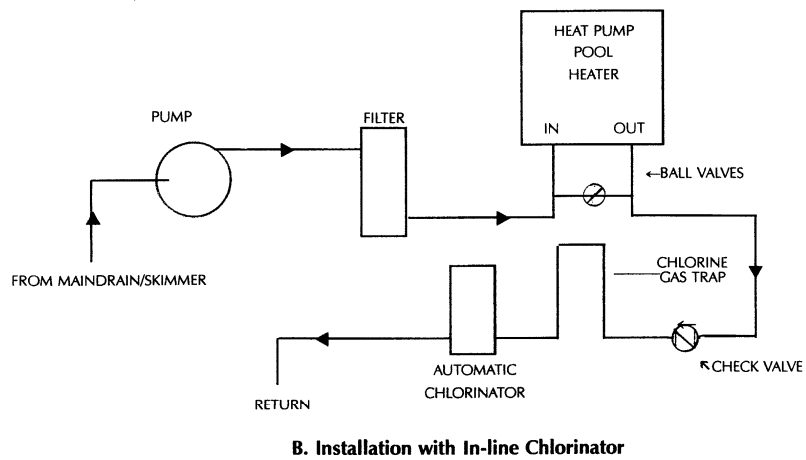
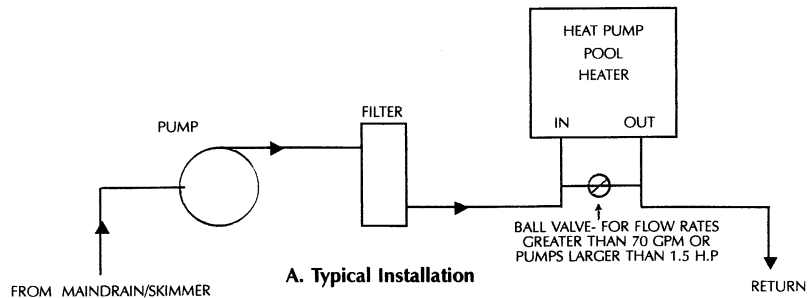

---

## ELECTRICAL CONNECTIONS

---

Field connections must comply with national and local codes.

The work must be done by a qualified electrician.

### **Heater must be permanently grounded and bonded.**

Bonding will drastically reduce the chances of electrolysis, “Electrical Corrosion.”

Use copper conductors only.

Disconnect all power sources before performing any work on unit.

Standard Power Supply: 208/230 - 60 – 1

See unit data plate for specific ampacity.

### **Wiring Main Power Supply**

1. Remove the screws from lower left and right side of front cover (service panel).
2. Remove the screws on left side of hinged electrical enclosure.
3. Route weather tight flexible conduit through opening at base of unit. Connect conduit to the bottom of the electrical enclosure using a weather tight fitting. A knockout is provided to accept the weather tight fitting. Mounting conduit directly to the electrical enclosure will ensure a moisture tight seal, extending the life of the heater.
4. Attach grounding conductor to the ground lug provided inside the electrical enclosure (labeled).
5. Install L1 and L2 input conductors to the line side of the main contactor. (See wiring diagrams.)
6. Connect bond wire (at least #8 solid copper wire) from bond lug on right side of coil header panel to pool pump bonding terminal or other suitable location.

### **Install Heat/Cool Switch**

The switch to change from Heating to Cooling is removed from the electrical enclosure after testing at the factory to prevent damage during shipping. It must be reinstalled in the field at time of installation.

**REMOTE THERMOSTATS AND CONTROLLERS: *see page 6, SET UP MODE.***

# WIRING DIAGRAM

- CCC - COMPRESSOR CONTACTOR COIL
- RVS - REVERSING VALVE SOLENOID
- HPS - HIGH PRESSURE SWITCH
- LPS - LOW PRESSURE SWITCH
- WPS - WATER PRESSURE SWITCH
- DS - DEFROST SENSOR
- WS - WATER SENSOR
- RT - REMOTE TSTAT OR POOL/SPA SWITCH
- CES - COOL MODE ENABLE SWITCH

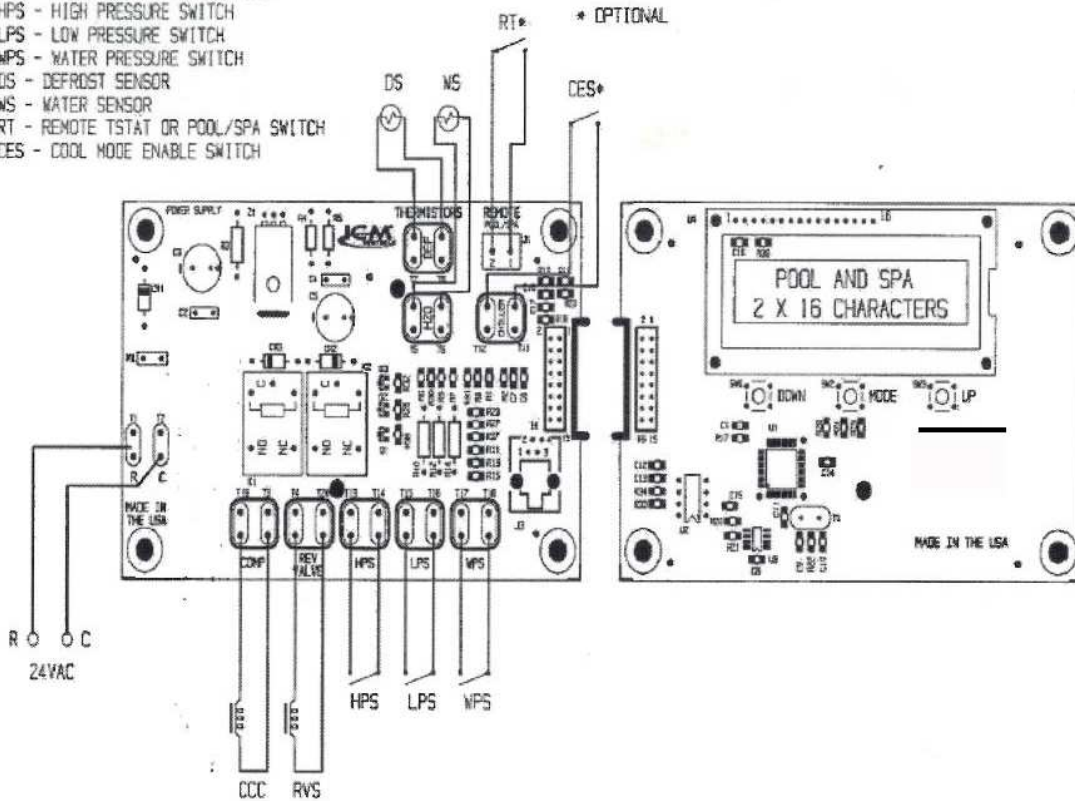

# FIELD WIRING DIAGRAM

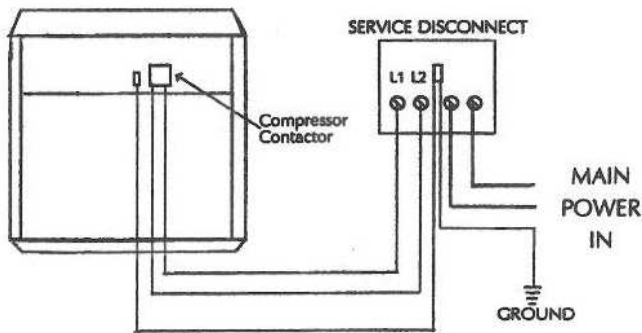

# NOTES

1. USE COPPER CONDUCTORS ONLY.
2. CONNECT FIELD WIRING IN GROUNDED WEATHER TIGHT CONDUIT, PER RATING PLATE.
3. CONNECT BOND WIRE TO POOL STEEL USING #8 SOLID COPPER WIRE OR LARGER.
4. ALL WIRING MUST CONFORM TO NATIONAL (N.E.C.) AND LOCAL ELECTRICAL CODES.

---

## SET UP MODE

---

**WARNING:** THE SET UP MODE IS DESIGNED AS AN ADVANCED USER'S AND INSTALLATION MENU; THE DIRECTIONS IN THIS SECTION MUST BE FOLLOWED CAREFULLY. AN ERROR IN PROGRAMMING MAY EFFECT THE OPERATION AND PERFORMANCE OF THE HEATER AND MAY RESULT IN UNNECESSARY OR ERRONEOUS SERVICE CALLS.

Enter the set up mode by pressing both the UP and DOWN buttons for 5 seconds. Once in the set up mode, you can advance from one screen to another by pressing the SELECT button. The setting within the screen can be adjusted by pressing the UP or DOWN button. To exit the set up mode press both UP and DOWN buttons at the same time for 5 seconds.

The following are screens in the SET UP mode:

### **POOL/SPA REMOTE**

With this setting you can enable or disable the remote capability of switching from pool to spa mode automatically. The use of an external water pressure switch in the spa piping is necessary. A two wire circuit must be connected from the water pressure switch to the terminals marked REMOTE POOL/SPA on the electronic control board. When enabled and the external water pressure switch is closed the control will operate in spa mode, when the switch is opened the heater will operate in pool mode. The default setting is "DISABLED".

### **REMOTE THERMOSTAT**

With this setting you may enable or disable the remote capability. In the POOL MODE, you will have the capability to call for heating or cooling depending in which mode the Heat/Cool switch on the heat pump is set in. In SPA MODE you will have the capability to turn the heating on and off. Enabling the remote thermostat and closing the "external switch" will call for heating or cooling regardless of the temperature set point. In the case of a remote thermostat where the temperature will be regulated externally, set the SPA temperature to 104 degrees F (40 C) and leave the heat pump controller in the SPA MODE. The heat pump will run only when the remote calls for heating or cooling. The default setting is "DISABLED."

### **TIME DELAY**

With this setting you can adjust the time delay for compressor turn on. When set to "0" the control is in test mode. Test mode will exit automatically after 10 minutes or if power is turned off. *Note: control will flash "Delay" when ever the time delay applies.* The default setting is "5."

### **SPA TIMER**

With this setting you can adjust the time you spend in the spa in which heat is provided. The spa timer can be set Continuous, Off, or for a time interval between 15 minutes and 20 hours in increments of 15 minutes. Default setting is "CONTINUOUS."

## TEMPERATURE SCALE

With this setting you have the choice of the displayed temperature in Fahrenheit or Celsius.  
Default setting is “F.”

## DEFROST SELECTION

With this setting you can select whether defrosting shall be done in with air flow or by energizing the reversing valve. By pressing either up or down you can toggle between “AIR DEFROSTING” or “REVERSE CYCLE”. Default setting is “AIR DEFROSTING.”.

## WATER SENSOR CALIBRATION

With this setting you can calibrate the water temperature reading. The calibration range is +/- 10 degrees F or +/- 5 degrees Celsius.  
Default setting is “0”.

## EVAPORATOR SENSOR CALIBRATION

With this setting you can calibrate the evaporator temperature reading. The calibration range is +/- 10 degrees Fahrenheit or +/- 5 degrees Celsius. Default setting is “0”.

---

## ELECTRONIC CONTROL PANEL

---

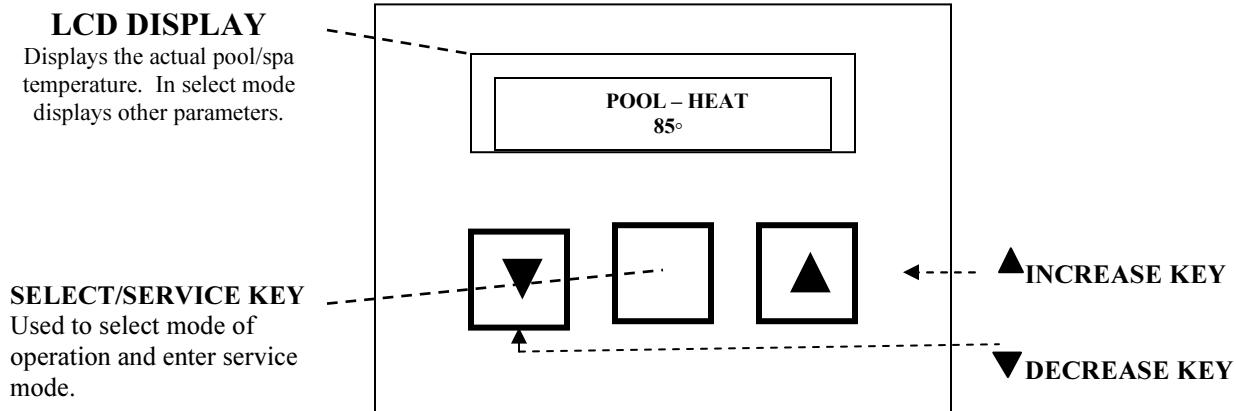

## MODE SELECTION

### NORMAL MODE

- When power is applied, the heater will turn on in the last mode in which it was used.
- User adjustable temperature range will be 50 to 95 degrees in Pool mode and 50 to 104 degrees in Spa mode.

- When user lowers the set point below 50 degrees F in one of these modes, that mode will be turned OFF.

**NOTE: AN EXTERNAL SWITCH LOCATED ON FRONT OF THE CONTROL PANEL IS USED TO TOGGLE BETWEEN HEAT AND COOL.**

## **POOL MODE – HEATING**

When operating in pool heat mode display will show POOL – HEAT on the top line and the actual pool water temperature on the bottom line. **FOR EXAMPLE:**

**POOL – HEAT**  
**95°**

- To adjust the temperature set point user will press either the Up or DOWN button once. The Display will show “POOL TEMPERATURE” on the top line and the current set point temperature on the bottom line for 5 seconds (for example: SETPOINT 95F). Adjust the set point by pressing either UP or DOWN until the new set point is reached for heating.
- The display will revert to “POOL – HEAT” after 5 seconds of inactivity and the new set point will be stored in memory.
- When the water temperature falls 1 degree below the set point, the control will energize heating mode (compressor) after the time delay has expired. *The time delay is necessary to ensure proper water pressure within the pool filter system and to avoid short-cycling the compressor.*
- During heating once the water temperature reaches the set point, compressor is turned off.

## **POOL MODE – COOLING**

When operating in pool cool mode the display will show POOL – COOL on the top line and the actual pool water temperature on the second line. **FOR EXAMPLE:**

**POOL – COOL**  
**70°**

- An external switched located on the front of the control panel is used to toggle between heat and cool. Control will switch to cool mode by closing the switch in which case display will show POOL – COOL on the top line and the current temperature on the bottom line.
- To adjust the temperature point user will press either the UP or DOWN button once. The display will show “POOL TEMPERATURE” on the top line and the current set point temperature on the bottom line for 5 seconds. Adjust the set point by pressing either UP or DOWN until the new set point is reached for cooling.
- The display will revert to “POOL – COOL” after 5 seconds of inactivity and the new set point will be stored in memory.
- When the temperature becomes 1 degree greater than the set point, the control will energize cooling mode (compressor and reversing valve)) after the time delay has expired.
- During cooling once the water temperature reaches the set point, the compressor is turned off.



## **SPA MODE – HEATING**

When operating in spa mode display will show SPA – HEAT on the top line and the actual spa water temperature on the second line. **EXAMPLE:**

**SPA – 104°**

- To operate in SPA mode user will press the POOL/SPA button (center hand button) once. After pressing the POOL/Spa button, the display will show “SPA TEMPERATURE” on the top line and the current temperature set point on the bottom line for 5 seconds. Adjust the set point by pressing either UP or DOWN until the new set point is reached for spa heating.
- The display will revert back to “SPA – HEAT” and the current spa temperature after 5 seconds of inactivity and the new set point will be stored.
- When the spa water temperature falls 1° F below the set point, the control will energize spa heating mode (compressor) after the time delay has expired.
- During heating once the water temperature reaches the set point, the compressor turns off.

---

## **CHEMICAL USE**

---

Water quality must be checked regularly and maintained within recommended limits at all times. Failure to maintain the proper water quality will greatly reduce the life of your heater.

- Never add chemicals directly into skimmer.
- Automatic chlorinators must be piped downstream from the heater. A check valve must be installed between the chlorinator and heater to prevent raw chlorine from draining back into the heater. A chemical trap may be piped at least six (6) inches above the chlorinator. See piping diagram B.

**Always maintain the following water quality requirements:**

**PH LEVEL 7.4 to 7.8**  
**CHLORINE CONCENTRATION 1 to 5 PPM**  
**TOTAL ALKALINITY 100 to 200 PPM**  
**CALCIUM HARDNESS 100 to 300 PPM**

---

## START-UP

---

Before proceeding with this section make certain all plumbing connections are airtight and leak free.

Flow rates should not exceed 70 GPM maximum. Use of an external bypass is necessary at 70 GPM and above. Minimum flow rate is 20 GPM.

- Turn filter pump time clock to the ON position and set filter pump hours. For initial heating, the pool heater and filter pump may need to run continuously until your desired temperature is reached. After initial heating is achieved, the heater will run only to maintain your desired temperature.
- Turn power supply to heater ON.
- The control panel will light up and display either POOL – HEAT OFF or the actual pool water temperature.
- Select POOL TEMPERATURE SETPOINT or SPA TEMPERATURE SETPOINT and set your desired water temperature by scrolling either up or down.
- If your programmed water temperature is above the actual water temperature and the 5 minute time delay is satisfied the compressor will start.

**NOTE: Each time the compressor turns off; it is protected by a 5 minute anti-cycling delay.**

## INITIAL HEATING

Initial heating may require you to run your heater and filter pump continuously for at least 24 hours, or more, depending on the following factors:

- Temperature difference between actual water temperature and desired water temperature.
- Size of pool.
- Ambient air temperature, the cooler the air temperature the longer the heating time.
- Heat loss (evaporative, convective, radiative and conductive).
- A pool cover / solar blanket may reduce initial heating time by up to 50 percent.

### **Reducing Heat Loss - Pool Cover / Solar Blanket**

We highly recommend the use of a pool cover / solar blanket. Covering your pool is the single most cost effective means of reducing heat costs from 50 to 70 percent. Heating a pool without a cover is like heating a house without a roof. They also reduce the amount of maintenance costs. By reducing evaporation, covers reduce the quantity of chemicals needed.

Because evaporation accounts for about 70 percent of pool heat loss, the beneficial effect of using a pool cover /solar blanket can be dramatic.

### **Wind Speed Reduction**

Reducing wind velocity at the water surface reduces convective and evaporative losses. Fences, trees, hills, or tall hedges close to the pool perimeter are effective windbreaks. Locate these obstructions to take maximum advantage of their effectiveness as windbreaks, without shading the pool surface from the sun.

### **Defrost Cycle**

The heat pump pool heater has automatic defrost. When the outdoor temperature drops below 40 °F, frost may start to form on the evaporator coil. Frost buildup will be heaviest on humid days when the temperature is between 35-40°. During the defrost cycle, the display will show **“DEFROSTING”** to indicate that the unit is defrosting. During this time the fan is running and the compressor is inactive.

### **Internal Protection Analyzers**

The heater is equipped with internal devices to monitor and protect the integrity of the unit. Should an abnormal condition occur, these devices will interrupt the operation of the unit and may display the appropriate code on the control panel.

- **LOW WATER FLOW:** Indicated by **“FLO”**, **“HIGH REFRIGERANT PRESSURE”**, or **“3 HPS STRIKES LOCKOUT”** on the control panel. The heater is designed to run efficiently above twenty (20) GPM. If there is insufficient water flow, the unit will shut down, protecting the compressor. The usual causes for these conditions are a dirty pool water filter, a restriction in the return line (i.e. skimmer), or improper valve positioning.
- **NO WATER FLOW:** Indicated by **“LOW FLOW”** on the control panel. When the filter pump is off, or if the water flow to the heater is interrupted during the heating mode, the internal water pressure switch will shut down the unit. When normal water flow resumes, the heater will automatically restart itself.
- Other analyzer codes include: **“FL3”**, **“LP3”**, **“LP”**, **“dPO”**, **“PO”**, **“dPC”**, **“Pc”**, **“PLE”**, **“CSE”** and **“SPi”**.

The TROUBLESHOOTING CHECKLIST on page 11 goes into detail on these analyzers codes.

---

## MAINTENANCE

---

**WARNING: DISCONNECT ELECTRICAL POWER TO UNIT BEFORE STARTING ANY MAINTENANCE TO PREVENT SERIOUS INJURY FROM SHOCK.**

### **Protecting your Heater**

- Keep your pool filter system clean and free of restrictions to ensure proper water flow.
- Check water chemistry regularly. Misuse of chemicals will cause permanent damage to your heater and other pool equipment. Manufacturers can void warranties for damage as a result of poor water quality.
- Free airflow is essential. Keep the evaporator coil clean and free of weeds, leaves, glass clippings, dirt and other debris that will decrease the airflow. Keep fences and shrubs away from air inlets (sides and back of heater).
- Frequent rinsing of the evaporator with fresh water will remove build up from its surface. Always spray the coil gently with a regular garden hose being careful not to bend aluminum fins.
- Regular cleaning of the cabinet will improve its appearance and extend the life of the finish.

### **Winterizing**

When the heater is exposed to freezing temperatures, it is essential that all water within the unit be properly drained. When water freezes, it expands, damaging piping.

- Turn thermostat settings to OFF. Turn filter pump to OFF.
- Turn power to unit OFF (i.e. pull disconnect or turn circuit breaker OFF).
- Disconnect water inlet and outlet unions at the back of the unit. Be careful not to lose rubber o-rings.
- Flush the heater piping out with fresh water to remove any residual chemicals.
- Use low-pressure air or vacuum to remove water that has accumulated inside the piping of the heater.

---

## TROUBLESHOOTING CHECKLIST

---

- Check to see that the electrical power is on. Reset breakers, or replace fuses if necessary.
- Check to be sure the electric control panel is set properly. The desired temperature must be set above the actual pool or spa temperature for the heater to run.
- Check to make sure the evaporator coil has enough clearance and that there are no restrictions to its airflow.
- Certain ambient air conditions may cause the heater to go into defrost mode, displayed on the control panel as “**AIR DEFROSTING**” or “**REVERSE CYCLE.**”

**NOTE: IT IS NORMAL FOR WATER TO DRIP FROM THE DRAINHOLES AT THE BASE OF THE HEATER. THE UNIT PRODUCES CONDENSATE WHEN IT OPERATES.**

### **Analyzer Codes**

**FAILURE LOCK-OUT:** This feature is for the protection of the heater. If the same failure occurs three (3) times within an hour, the control will not allow the unit to restart, and shall display the appropriate code (i.e. “”, **“3 LPS STRIKES LOCKOUT”**, or **“3 HPS STRIKES LOCKOUT”**). The reset to normal conditions can be accomplished by pressing any button on the control touch pad.

#### **“LOW FLOW”** (Little or No Water Flow)

- The pump is not running.
- The filter is dirty or clogged.
- Shortage of water to pump - air leak.
- Undersized pump.
- Valves not in correct position.
- Filter in backwash mode.
- Water pressure switch needs adjustment, or is defective.

#### **“HIGH REFRIGERANT PRESSURE”** (Compressor High Pressure)

- Low water flow to heater.
- Defective high-pressure switch.

#### **“LOW REFRIGERANT PRESSURE”** (Compressor Low Pressure)

- Evaporator coil dirty.
- Fan motor not running.
- Low refrigerant pressure.
- Defective low-pressure switch.

**“EVAPORATOR SENSOR MALFUNCTION”** Evaporator temperature sensor connection opened or shorted. Check for cut or loose sensor wiring or defective sensor.

**“WATER SENSOR MALFUNCTION”** Water temperature sensor connection open or shorted. Check for a short in sensor wiring or defective sensor.

**“DEFROSTING”** or **“REVERSE CYCLE”** Heat pump in defrost cycle.

**SERVICE PERFORMED WITHIN THE WARRANTY PERIOD MUST BE APPROVED BY AQUA COMFORT TECHNOLOGIES, LLC. PRIOR TO SERVICE BEING PERFORMED AND ONLY BY A AQUA COMFORT TECHNOLOGIES AUTHORIZED TECHNICIAN. SEE WARRANTY FOR DETAILS.**

Please have the following ready before calling:

MODEL #:

SERIAL #:

DATE OF INSTALLATION:

NAME OF OWNER:

ADDRESS:

CONTACT #:

NATURE OF PROBLEM: